

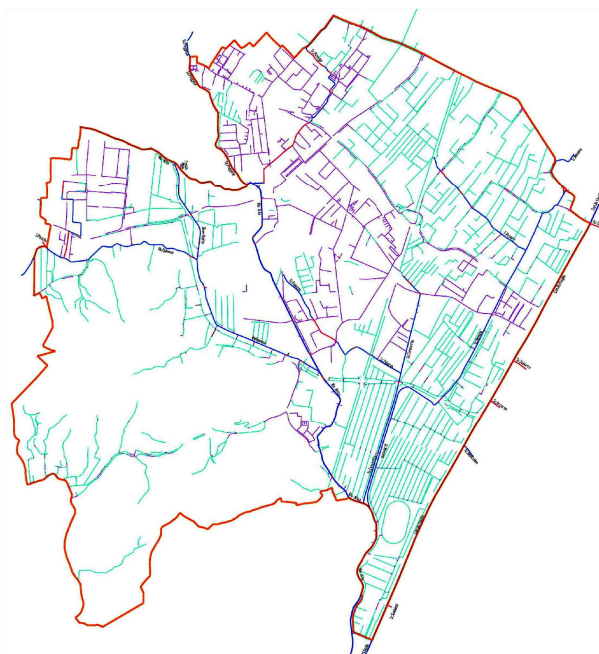

COMUNE DI MONTEGROTTO TERME
Piazza Roma n°1, 35036, Montegrotto Terme (PD)

PIANO COMUNALE DELLE ACQUE (CON PROGRAMMAZIONE DEGLI INTERVENTI) DI MONTEGROTTO TERME



TITOLO ELABORATO

TABELLA SEZIONI (Rif. All. B3)

CODICE
ELABORATO

A8

SCALA

-

REVISIONE	DATA	MOTIVO	
01	04/2015	Prima Emissione	
02	07/2015	Emissione Finale	
ESEGUITO	VERIFICA TECNICA	VERIFICA SICUREZZA	APPROVATO
G.R.	G.R./G.Z.	G.R./G.Z.	G.Z.

PROGETTAZIONE

ing. Giuliano Zen
sed. legale: 31037 Loria TV - via Cantoni di Sotto 35/a
tel. 0423470471 - fax 0423470471
e-mail: valedo@valedo.com
pec: giuliano.zen@ingpec.eu
C.F. ZNEGLN59L21C111V - P.I. 01886560265

Riproduzione vietata - Legge n° 633 del
22/04/1941 e successivi aggiornamenti

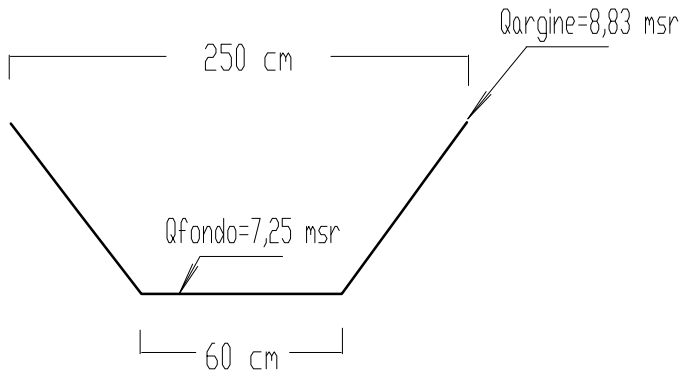

SEZIONE S001
(fuori scala)

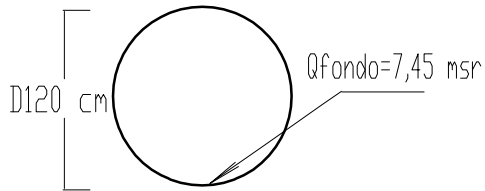

SEZIONE S002
(fuori scala)

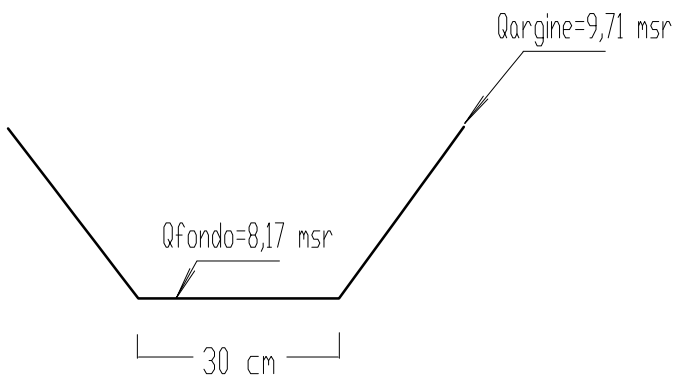

SEZIONE S003
(fuori scala)

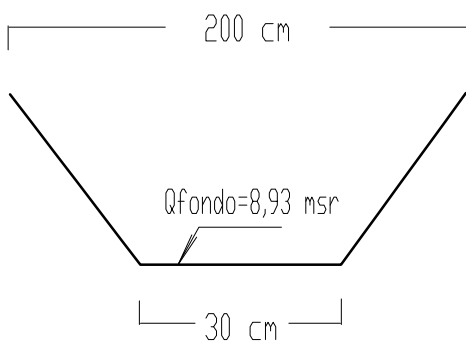

SEZIONE S004
(fuori scala)

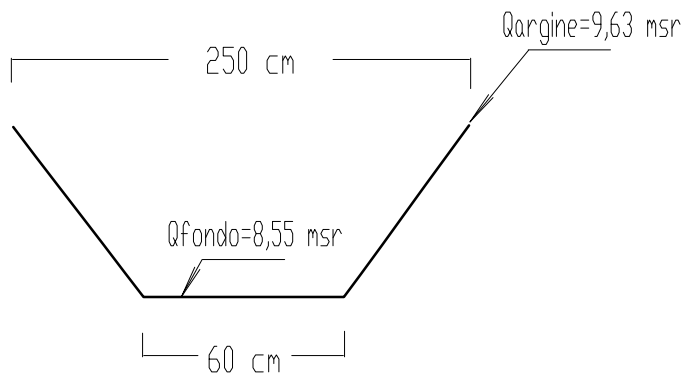

SEZIONE S005
(fuori scala)

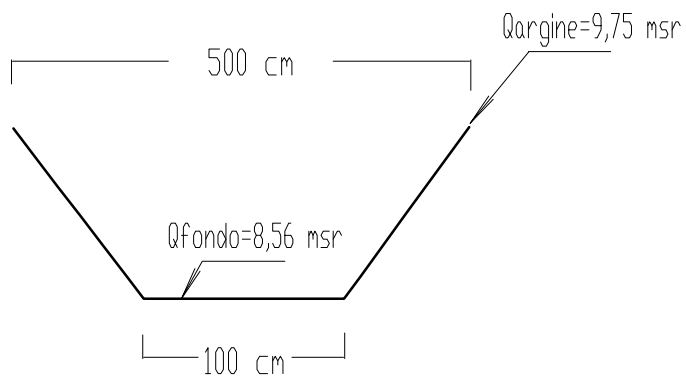

SEZIONE S006
(fuori scala)

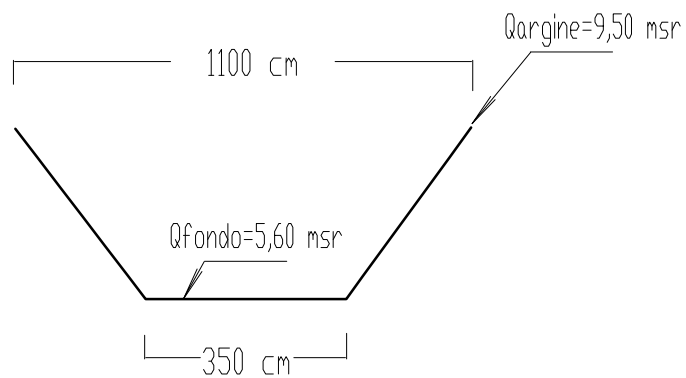

SEZIONE S007
(fuori scala)

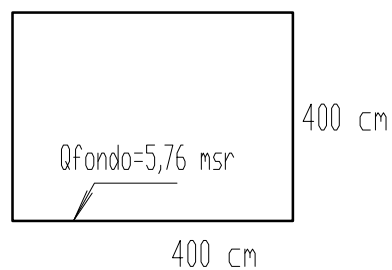
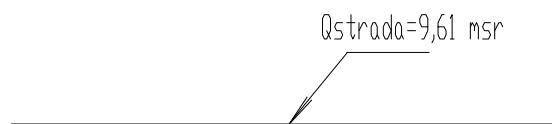

SEZIONE S008
(fuori scala)

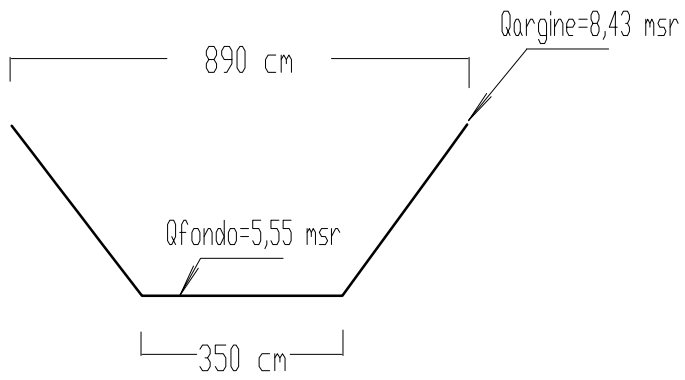

SEZIONE S009
(fuori scala)

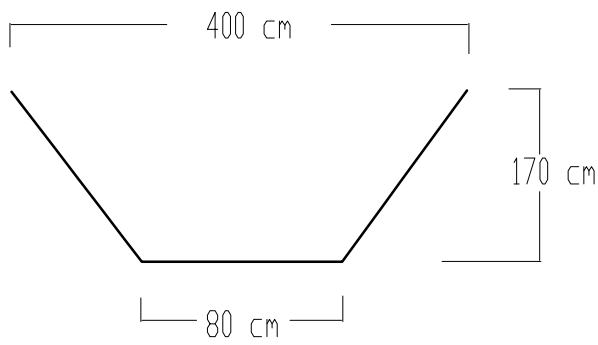

SEZIONE S010
(fuori scala)

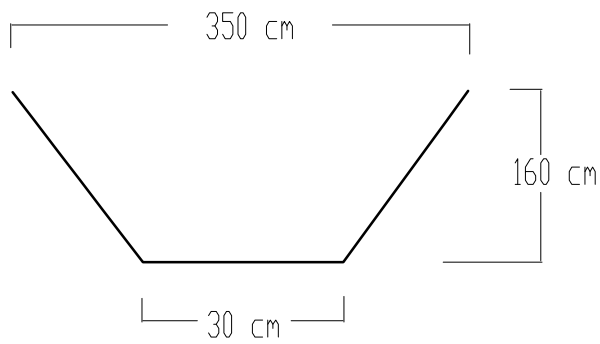

SEZIONE S011
(fuori scala)

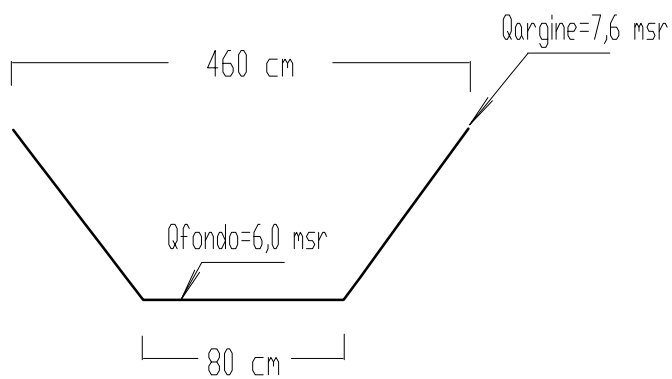

SEZIONE S012
(fuori scala)

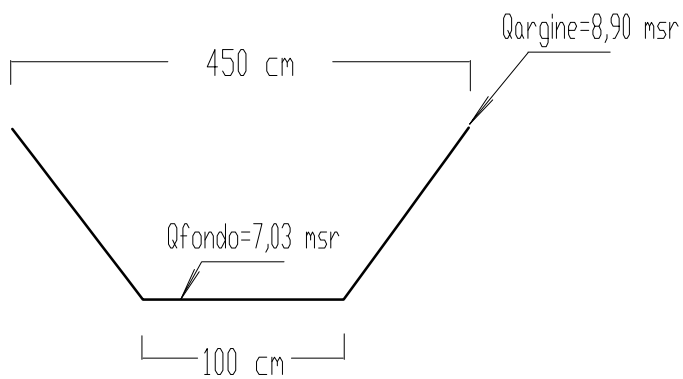

SEZIONE S013
(fuori scala)

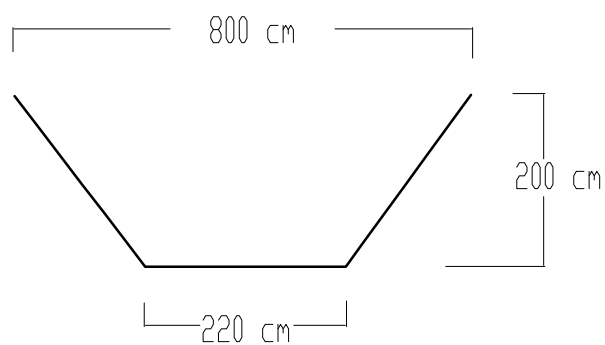

SEZIONE S014
(fuori scala)

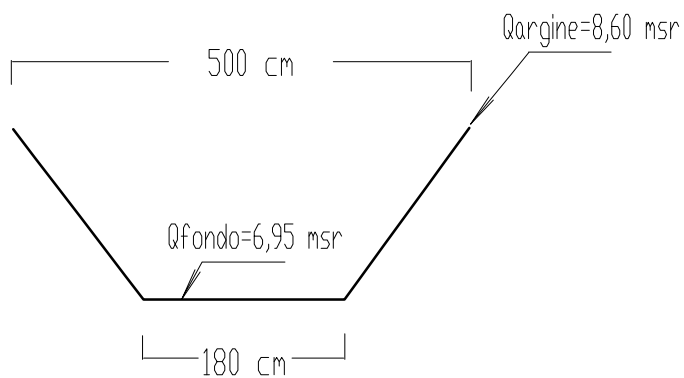

SEZIONE S015
(fuori scala)

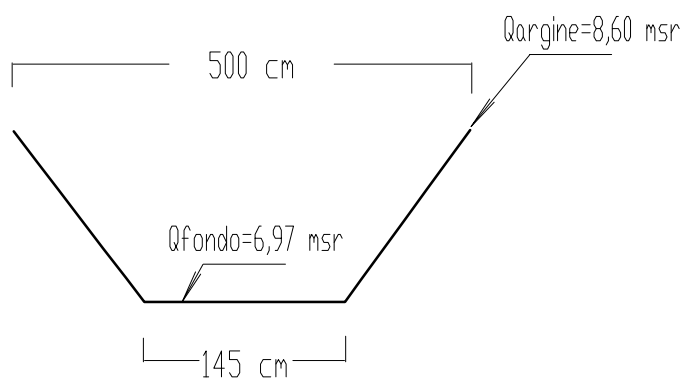

SEZIONE S016
(fuori scala)

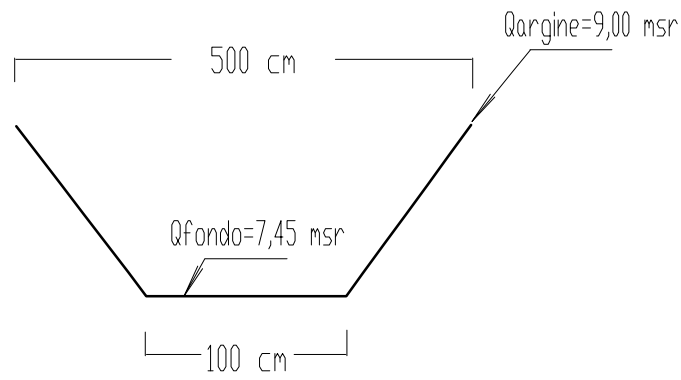

SEZIONE S017
(fuori scala)

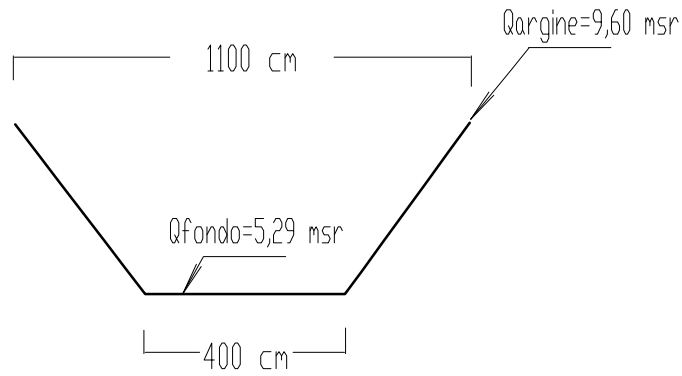

SEZIONE S018
(fuori scala)

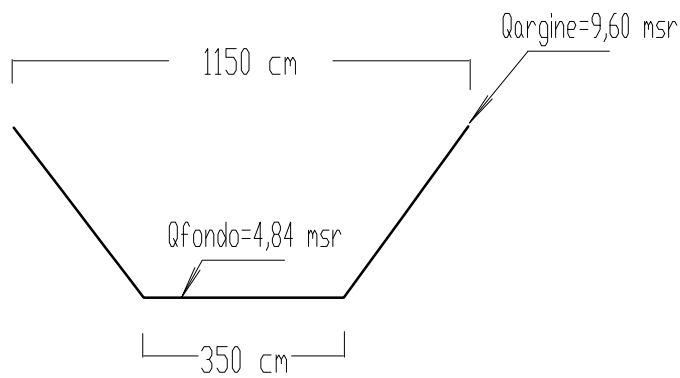

SEZIONE S019
(fuori scala)

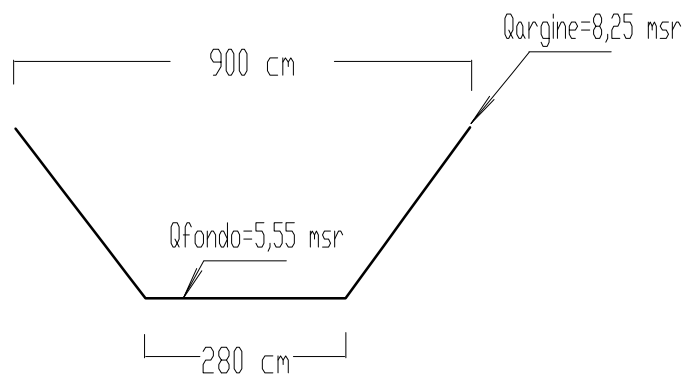

SEZIONE S020
(fuori scala)

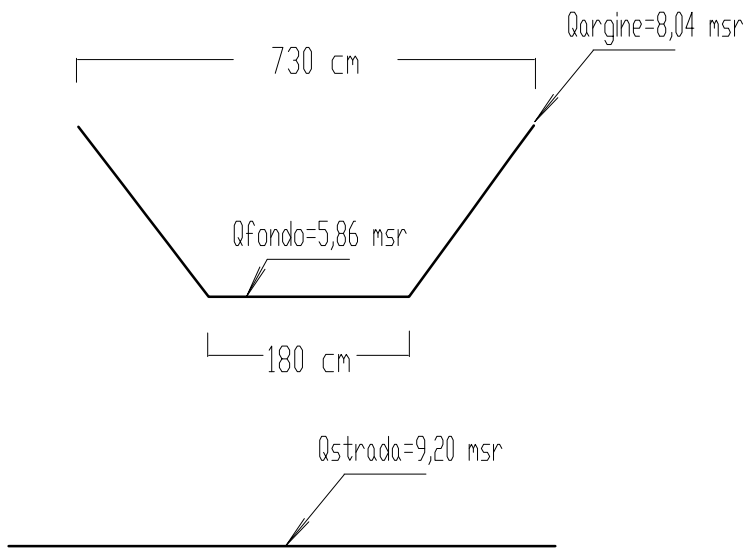

SEZIONE S021
(fuori scala)

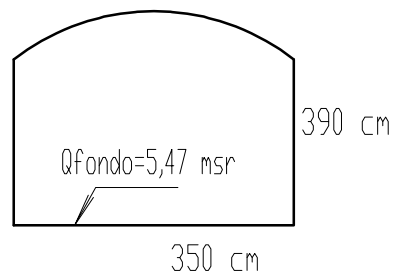

SEZIONE S022
(fuori scala)

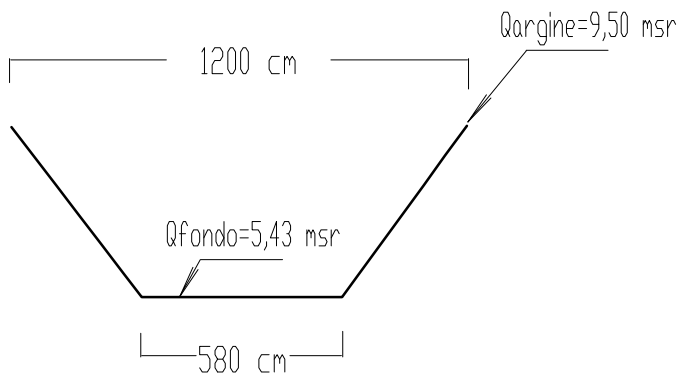

SEZIONE S023
(fuori scala)

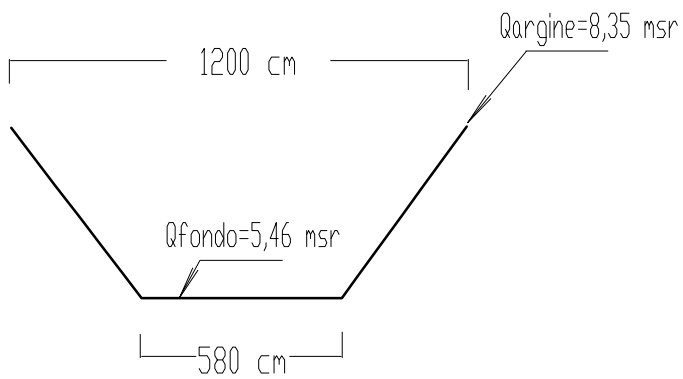

SEZIONE S024
(fuori scala)

QS=5,46

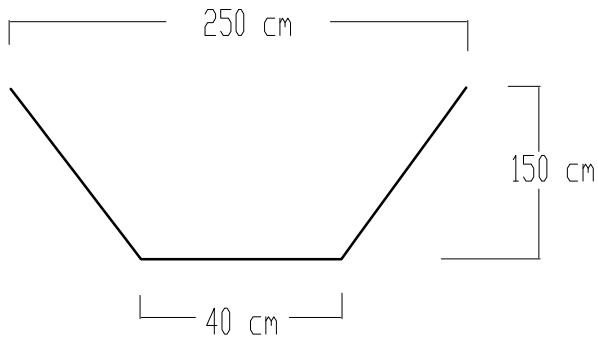

SEZIONE S025
(fuori scala)

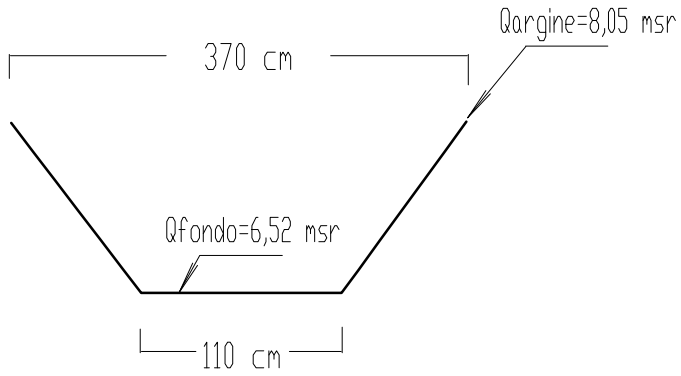

SEZIONE S026
(fuori scala)

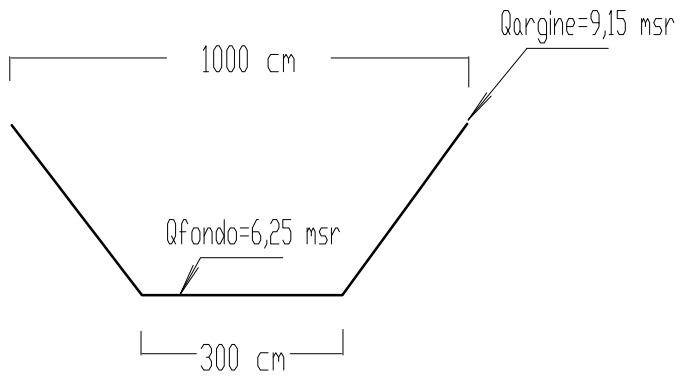

SEZIONE S027
(fuori scala)

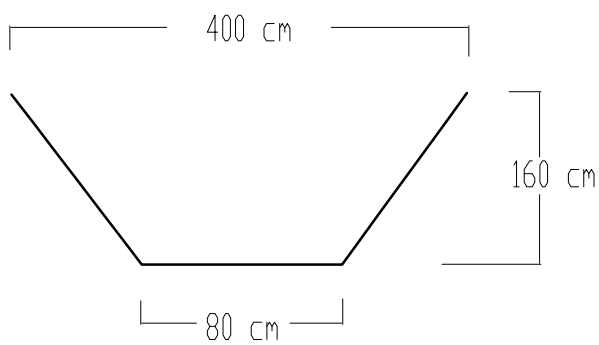

SEZIONE S028
(fuori scala)

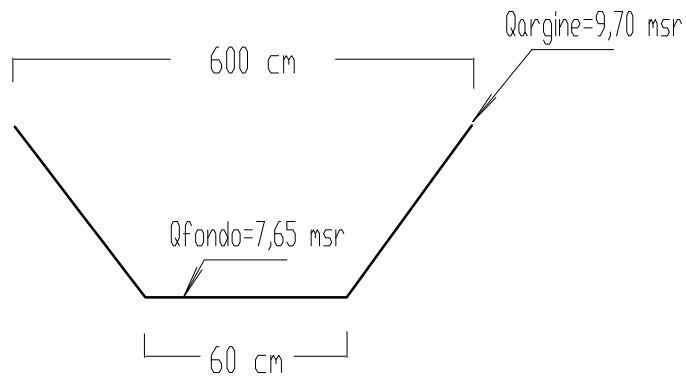

SEZIONE S029
(fuori scala)

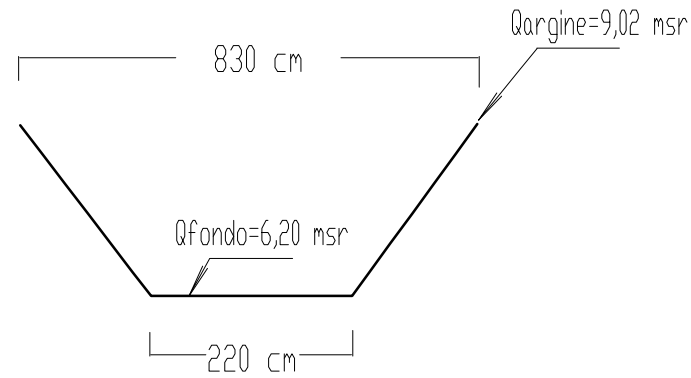

SEZIONE S030
(fuori scala)

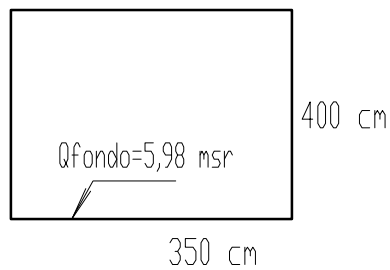
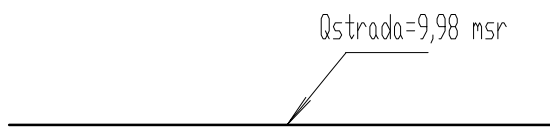

SEZIONE S031
(fuori scala)

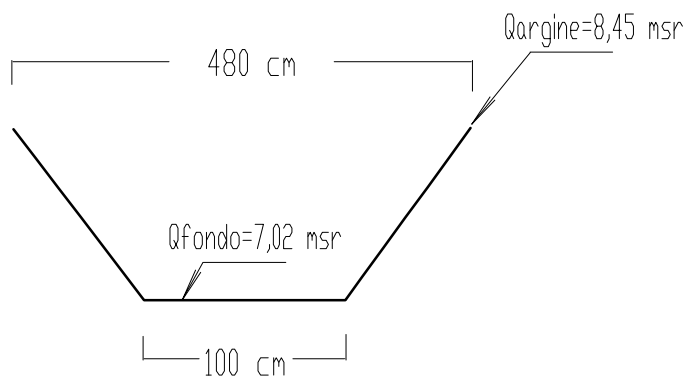

SEZIONE S032
(fuori scala)

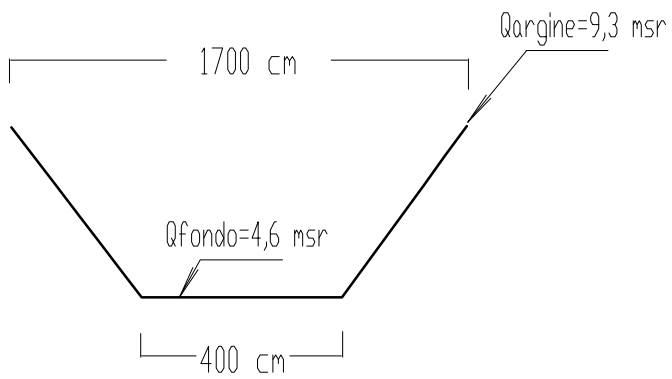

SEZIONE S033
(fuori scala)

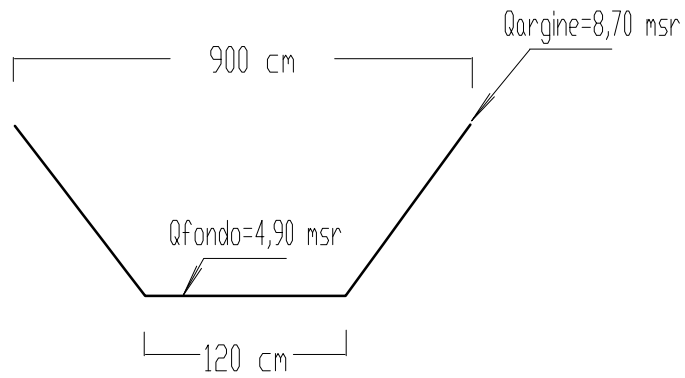

SEZIONE S034
(fuori scala)

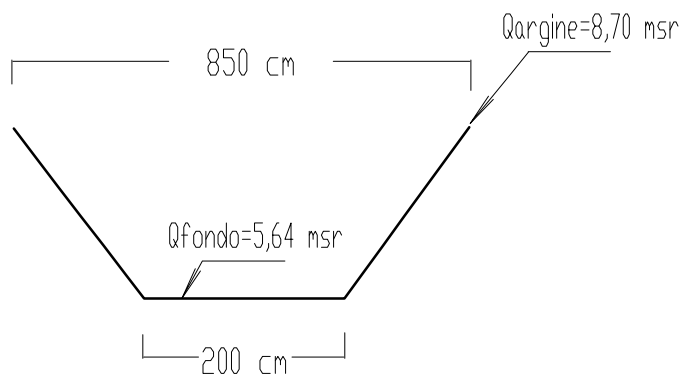

SEZIONE S035
(fuori scala)

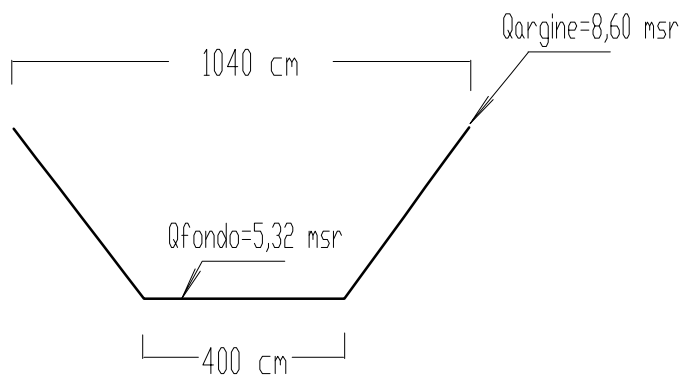

SEZIONE S036
(fuori scala)

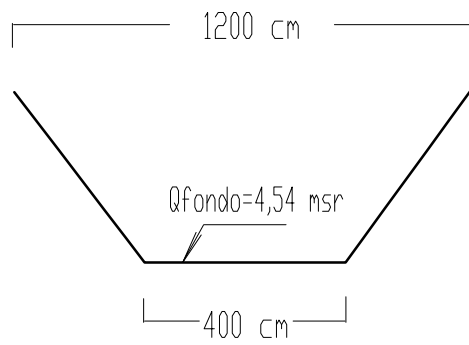

SEZIONE S037
(fuori scala)

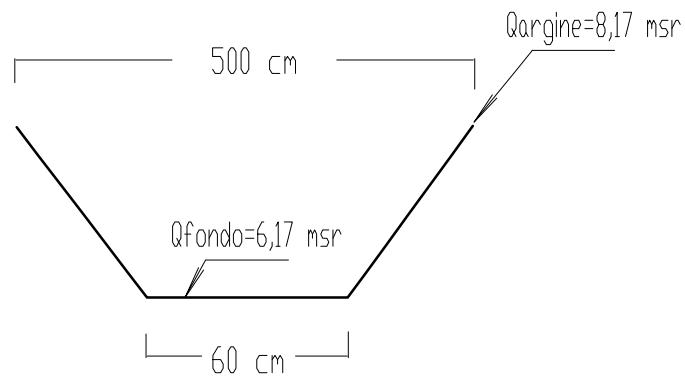

SEZIONE S038
(fuori scala)

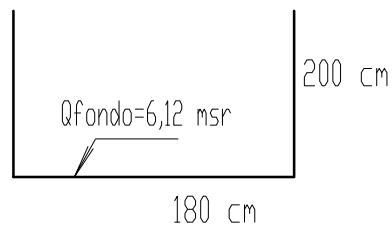

SEZIONE S039
(fuori scala)

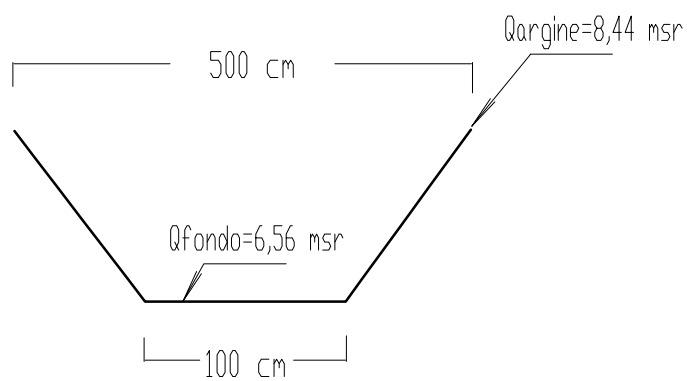

SEZIONE S040
(fuori scala)

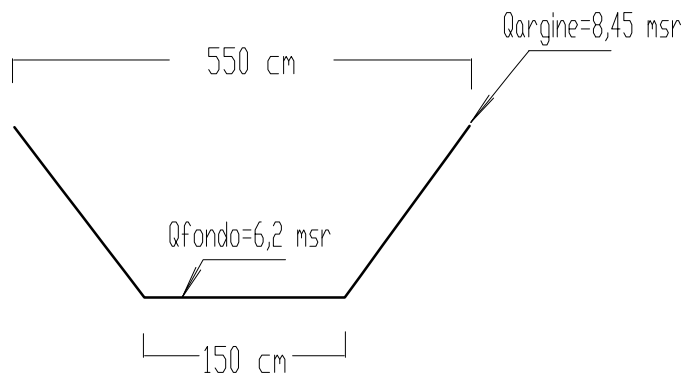

SEZIONE S041
(fuori scala)

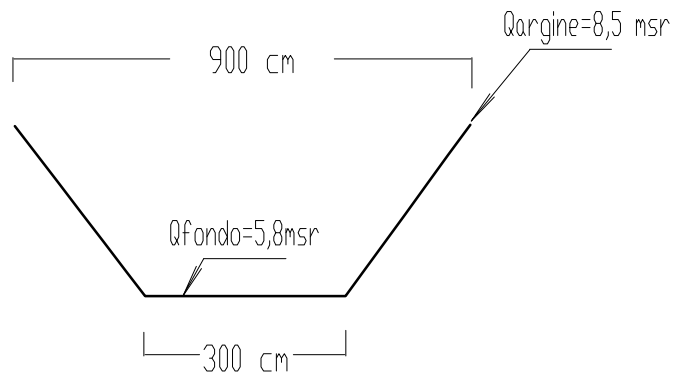

SEZIONE S042
(fuori scala)

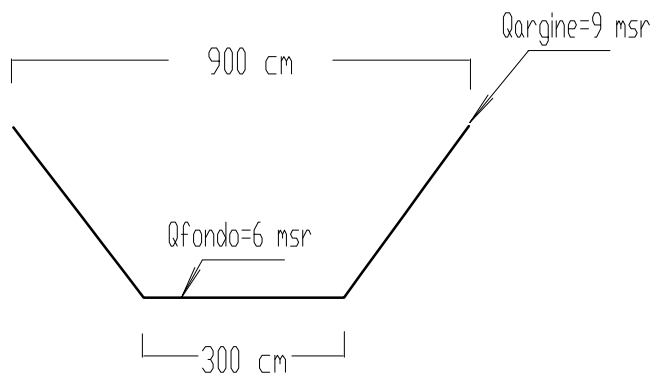

SEZIONE S043
(fuori scala)

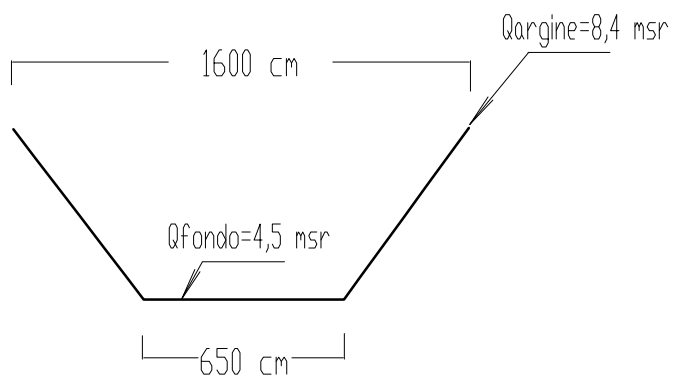

SEZIONE S044
(fuori scala)

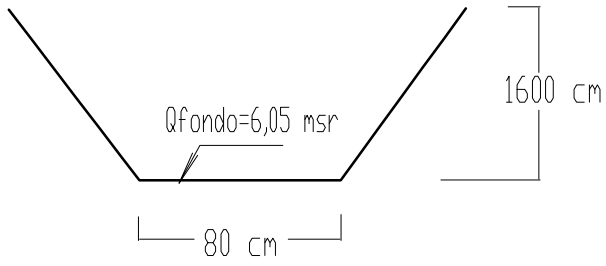

SEZIONE S045
(fuori scala)

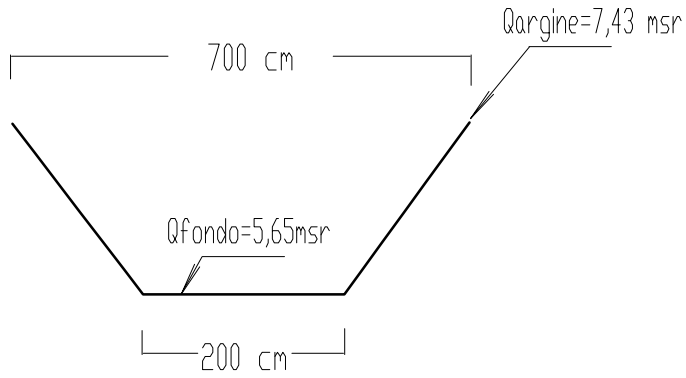

SEZIONE S046
(fuori scala)

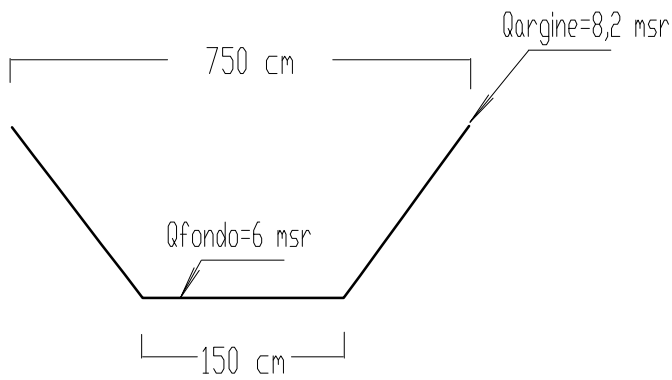

SEZIONE S047
(fuori scala)

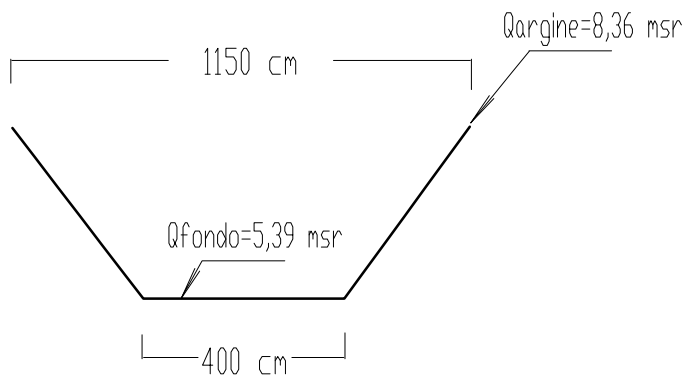

SEZIONE S048
(fuori scala)

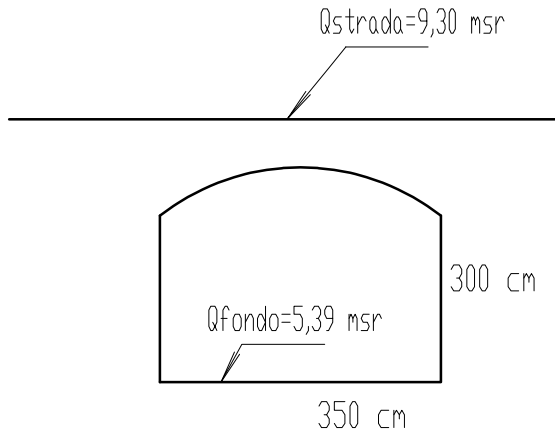

SEZIONE S049
(fuori scala)

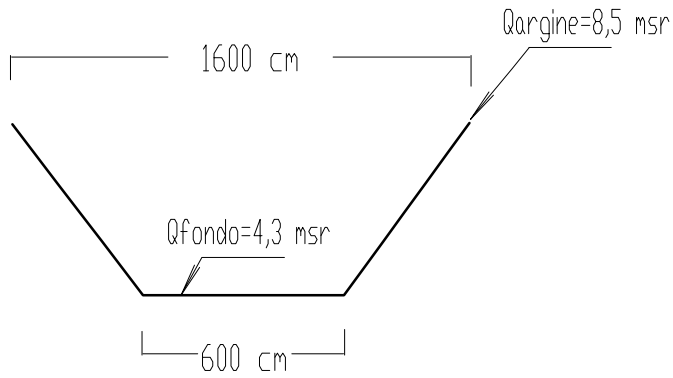

SEZIONE S050
(fuori scala)

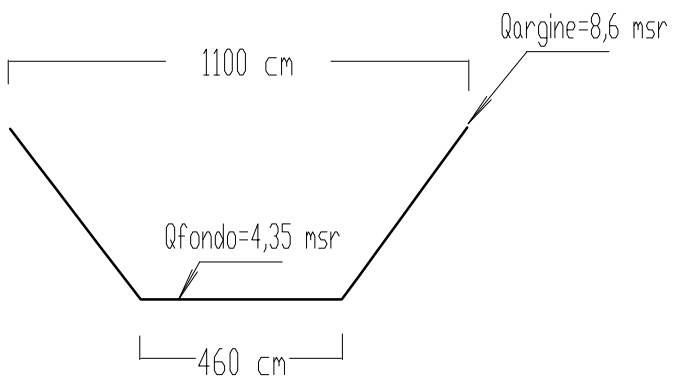

SEZIONE S051
(fuori scala)

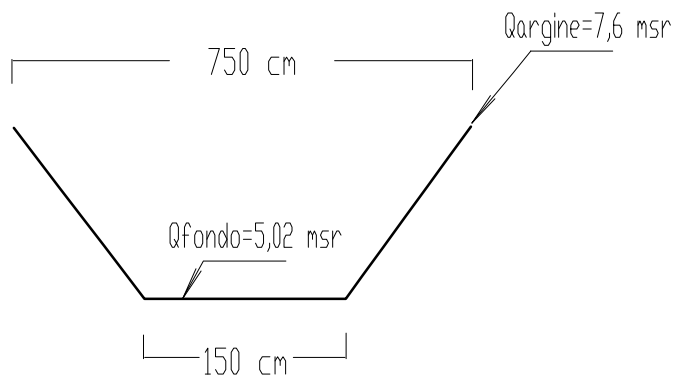

SEZIONE S052
(fuori scala)

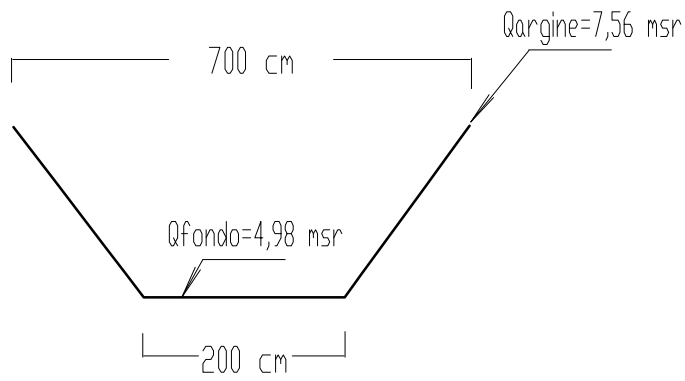

SEZIONE S053
(fuori scala)

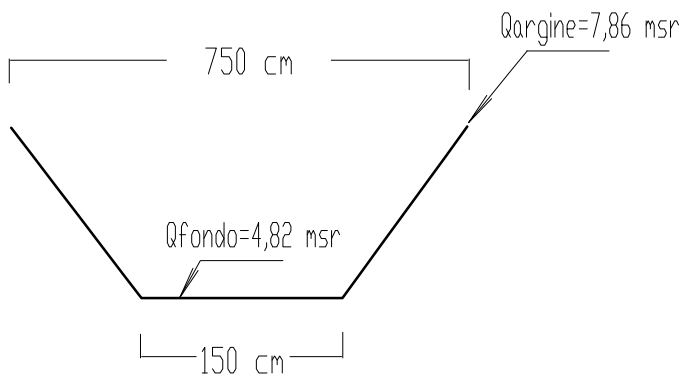

SEZIONE S054
(fuori scala)

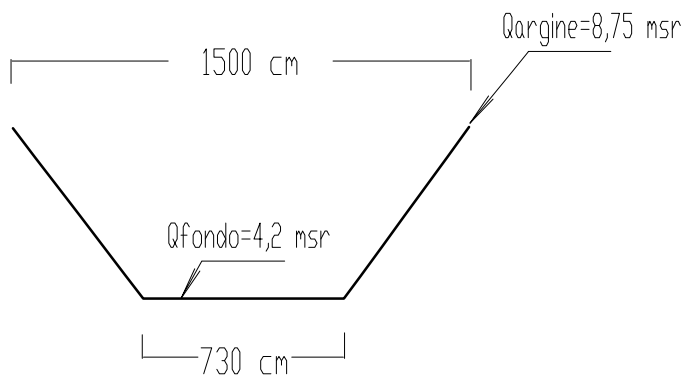

SEZIONE S055
(fuori scala)

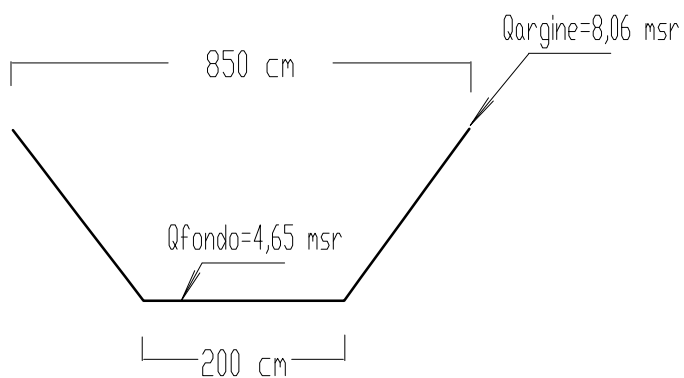

SEZIONE S056
(fuori scala)

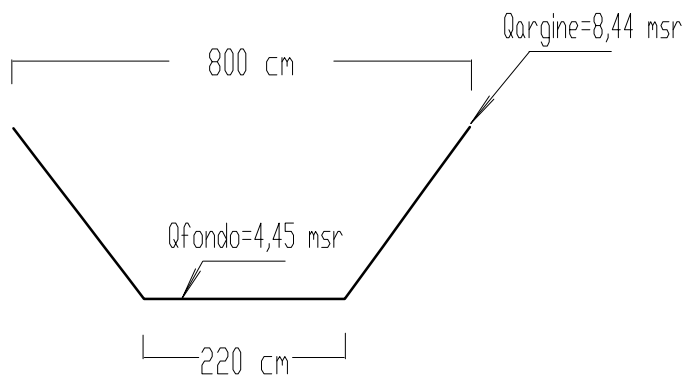

SEZIONE S057
(fuori scala)

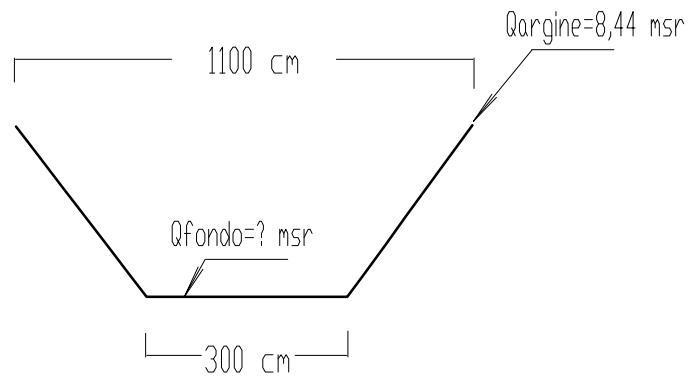

SEZIONE S058
(fuori scala)

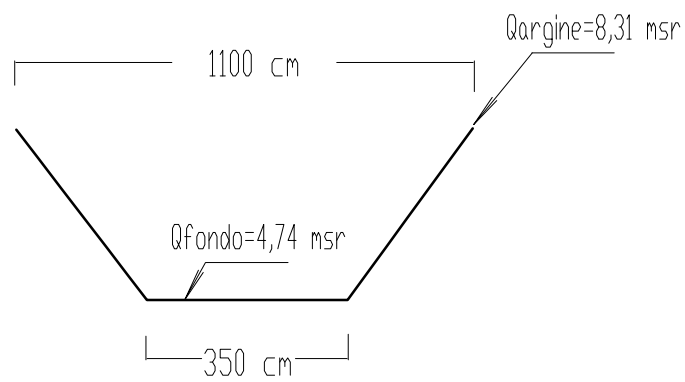

SEZIONE S059
(fuori scala)

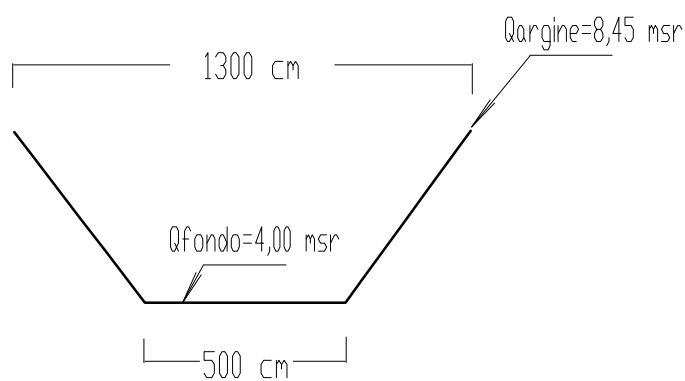

SEZIONE S060
(fuori scala)

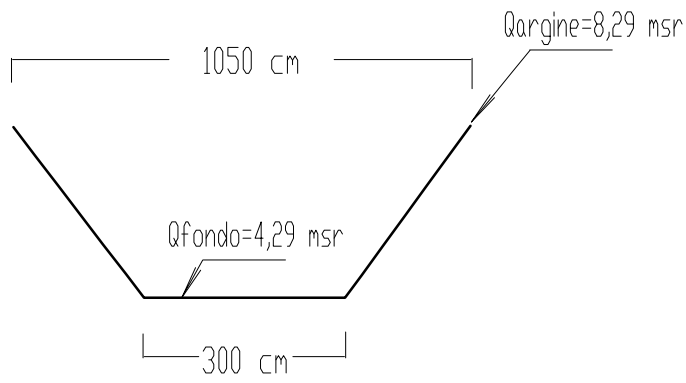

SEZIONE S061
(fuori scala)

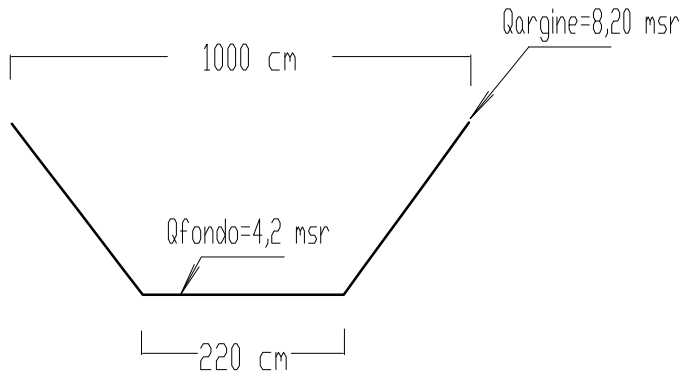

SEZIONE S062
(fuori scala)

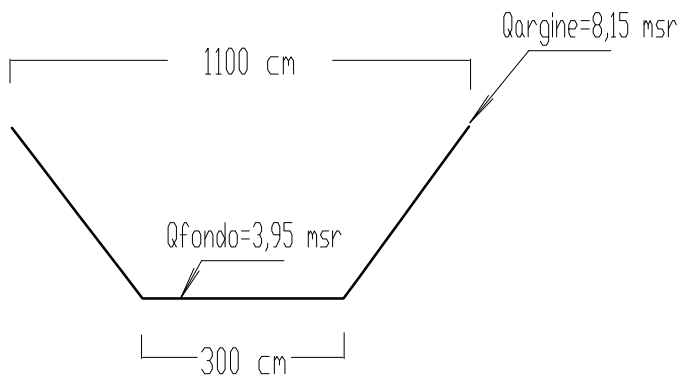

SEZIONE S063
(fuori scala)

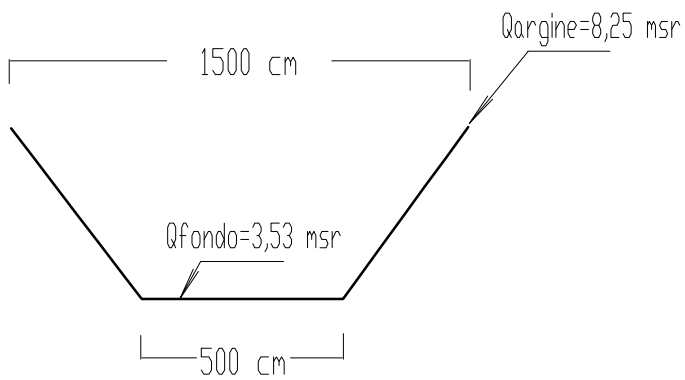

SEZIONE S064
(fuori scala)